

- 2.5" voice coil fiberglass former
- Ferrite magnet circuit
- 95.2 dB sensitivity



Specifications	
Nominal Diameter	385mm (15")
Nominal Impedance	8Ω
Rated Power AES ⁽¹⁾	250W
Continuous Program Power ⁽²⁾	500W
Sensitivity @ 1W/1m ⁽³⁾	95.2dB
Voice Coil Diameter	65mm (2,5")
Voice Coil Winding Depth	22mm
Magnetic Gap Depth	8mm
Flux Density	0.81T
Magnet Weight	1450g
Net Weight	5.4kg

Thiele & Small Parameters ⁽⁴⁾			
Re	5.70Ω	Fs	37.5Hz
Qms	11.91	Qes	0.44
Qts	0.43	Mms	116.1g
Cms	155μm/N	Bxl	18.71Tm
Vas	126.0l	Sd	754.8cm ²
X max ⁽⁵⁾	+/-5.0mm	X var ⁽⁶⁾	+/-7.0mm
η ₀	1.42%	Le (1kHz)	3.37mH

Constructive Characteristics	
Magnet	: Ferrite
Basket Material	: Pressed Sheet Steel
Voice Coil Winding Material	: Copper
Voice Coil Former Material	: Fiberglass
Cone Material	: Paper
Cone Treatment	: No
Surround Material	: Treated Cloth
Dust Dome Material	: Solid Paper

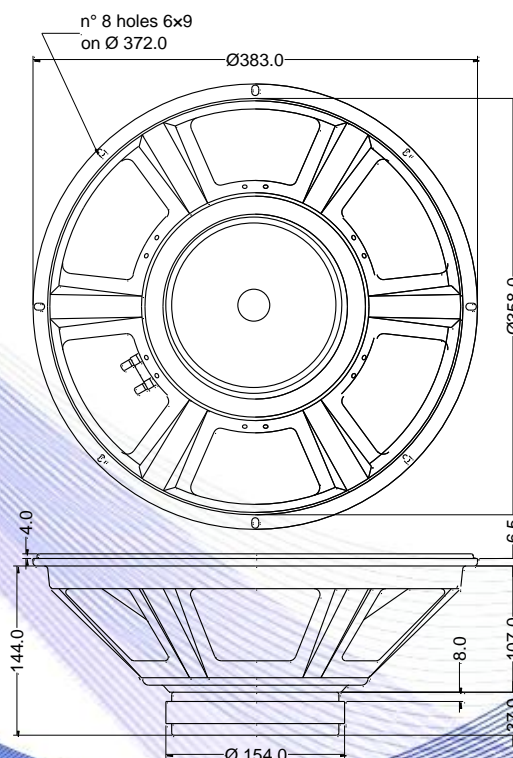

Frequency Response on IEC Baffle (DIN 45575) @ 1W,1m – Free Air Impedance

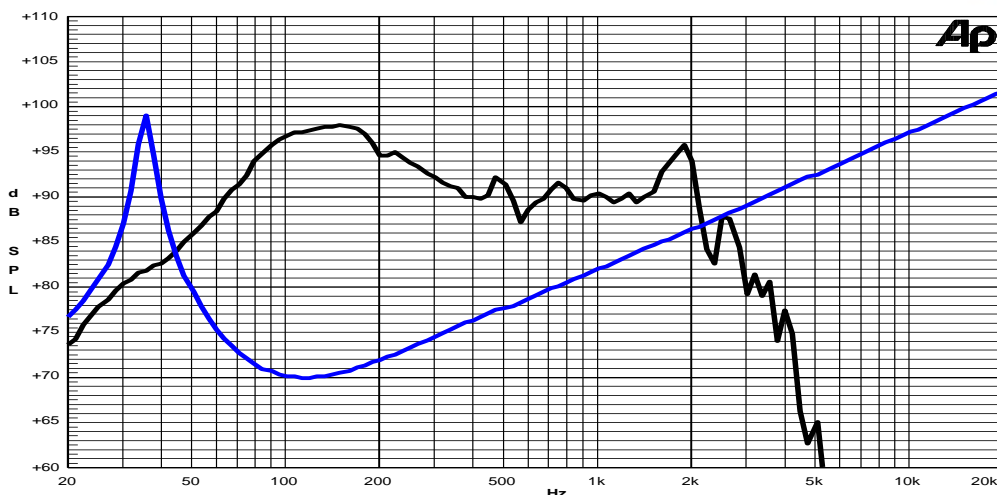

- Note:
- 1 : Rated Power measured with 2 hours test with pink noise signal, 6dB crest factor, loudspeaker mounted on enclosure
 - 2: Power on Continuous Program is defined as 3 dB greater than the Rated Power
 - 3: Calculated by Thiele & Small parameters
 - 4: Thiele & Small parameters measured with laser system without preconditioning test
 - 5: Measured with respect to a THD of 10% using a parameter-based method
 - 6: Value corresponding to a decay of the Force Factor, or Compliance, or both, equal to the 50% of the small signal value.
 - 7: Drawing dimensions: mm
 - 8: The notch around 400Hz on the frequency response is typical of the measurement on IEC baffle