

LOWS:
Tight

MIDS:
Firm

HIGHS:
Smooth

OVERDRIVE:
Crunchy

Sound Features:

Guitarist Description:

Extremely versatile. Warm clean tone with top-end chime.

It remains strong and articulate when presented with overdrive distortion.

Specifications	
Nominal Diameter	165 mm (6,5")
Nominal Impedance	8 Ω
Rated Power AES ⁽¹⁾	20 W
Continuous Program Power ⁽²⁾	40 W
Sensitivity @ 1W/1m	91.3 dB
Voice Coil Diameter	25 mm
Voice Coil Winding Depth	7 mm
Magnetic Gap Depth	5 mm
Flux Density	1.00 T
Magnet Weight	245 g
Net Weight	0.7 kg

Thiele & Small Parameters ⁽³⁾			
Re	6.58 Ω	Fs	106.3 Hz
Qms	10.65	Mms	6.8 g
Qts	1.08	Bxl	5.00 Tm
Cms	327 μm/N	Sd	122.7 cm ²
Vas	7.0 l	Le (1kHz)	0.48 mH

Constructive Characteristics	
Magnet	Ferrite
Basket Material	Pressed Sheet Steel
Voice Coil Winding Material	Copper
Voice Coil Former Material	Epotex
Cone Material	Paper
Surround Treatment	Yes
Surround Material	Paper - Integrated
Dust Dome Material	Non Treated Cloth

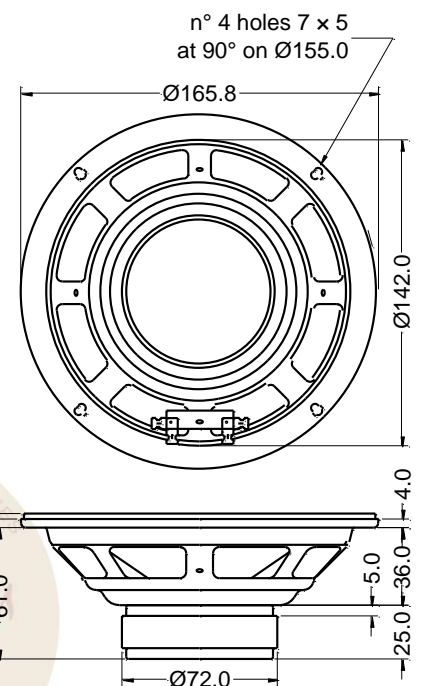
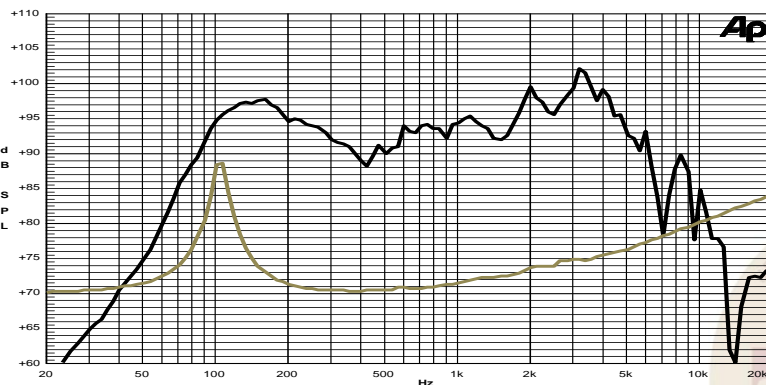

Note:

- 1: Rated Power measured with 2 hours test with pink noise signal, 6dB crest factor, loudspeaker mounted on enclosure
- 2: Power on Continuous Program is defined as 3 dB greater than the Rated Power
- 3: Thiele & Small parameters measured with laser system without preconditioning test
- 4: Drawing dimensions: mm
- 5: The notch around 400Hz on the frequency response is typical of the measurement on IEC baffle

