

LOWS:
Tight

MIDS:
Present

HIGHS:
Brilliant

OVERDRIVE:
Crunchy

Sound Features:

Guitarist Description:

Warm and natural sounding with a remarkably deep and controlled low end, a firm midrange, topped by a transparent, chimey treble range. Capable of crunchy overdriven tones, with a brilliant, detailed response.



Specifications	
Nominal Diameter	307 mm (12")
Nominal Impedance	8 Ω
Rated Power AES ⁽¹⁾	40 W
Continuous Program Power ⁽²⁾	80 W
Sensitivity @ 1W/1m	96.0 dB
Voice Coil Diameter	32 mm
Voice Coil Winding Depth	9 mm
Magnetic Gap Depth	6 mm
Flux Density	1.28 T
Magnet Weight	360 g
Net Weight	2.0 kg

Thiele & Small Parameters ⁽³⁾			
Re	5.90 Ω	Fs	93.2 Hz
Qms	14.29	Mms	28.7 g
Qts	1.36	Bxl	8.20 Tm
Cms	102 μm/N	Sd	490.9 cm ²
Vas	34.6 l	Le (1kHz)	0.40 mH

Constructive Characteristics	
Magnet	Reinforced AlNiCo
Basket Material	Pressed Sheet Steel
Voice Coil Winding Material	Copper
Voice Coil Former Material	Kapton
Cone Material	Paper
Surround Treatment	Yes
Surround Material	Paper - Integrated
Dust Dome Material	Non Treated Cloth

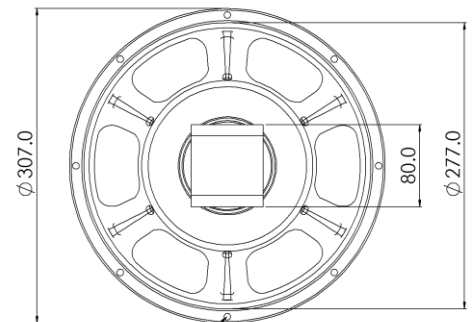

8 holes ϕ 6.5
on ϕ 293.5mm

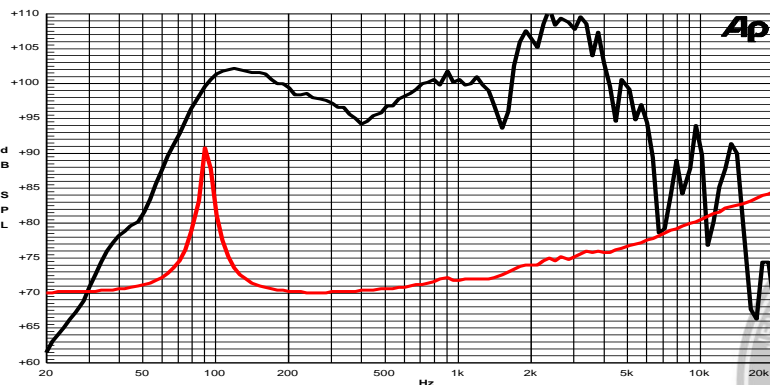
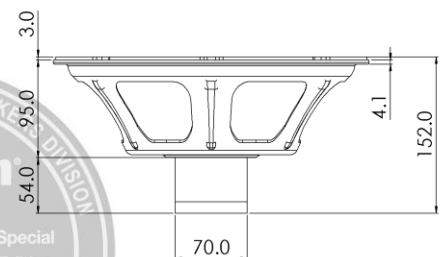

- Note: 1: Rated Power measured with 2 hours test with pink noise signal, 6dB crest factor, loudspeaker mounted on enclosure
 2: Power on Continuous Program is defined as 3 dB greater than the Rated Power
 3: Thiele & Small parameters measured with laser system without preconditioning test
 4: Drawing dimensions: mm
 5: The notch around 400Hz on the frequency response is typical of the measurement on IEC baffle

